

User Manual

1K/2K/3K Online UPS

Uninterruptible Power Supply System

Table of Contents

1. Important Safety Warning	1
1-1. Transportation	1
1-2. Preparation	1
1-3. Installation	1
1-4. Operation	1
1-5. Maintenance, service and faults	2
2. Installation and setup	3
2-1. Rear panel view	3
2-2. Setup the UPS	4
3. Operations	6
3-1. Button operation.....	6
3-2. LCD Panel	6
3-3. Audible Alarm	8
3-4. LCD display wordings index	8
3-5. UPS Setting	8
3-6. Operating Mode Description	11
3-7. Faults Reference Code.....	11
3-8. Warning indicator	12
4. Troubleshooting.....	13
5. Storage and Maintenance.....	15
6. Specifications	16

1. Important Safety Warning

Please comply with all warnings and operating instructions in this manual strictly. Save this manual properly and read carefully the following instructions before installing the unit. Do not operate this unit before reading through all safety information and operating instructions carefully

1-1. Transportation

- Please transport the UPS system only in the original package to protect against shock and impact.

1-2. Preparation

- Condensation may occur if the UPS system is moved directly from cold to warm environment. The UPS system must be absolutely dry before being installed. Please allow at least two hours for the UPS system to acclimate the environment.
- Do not install the UPS system near water or in moist environments.
- Do not install the UPS system where it would be exposed to direct sunlight or near heater.
- Do not block ventilation holes in the UPS housing.

1-3. Installation

- Do not connect appliances or devices which would overload the UPS system (e.g. laser printers) to the UPS output sockets.
- Place cables in such a way that no one can step on or trip over them.
- Do not connect domestic appliances such as hair dryers to UPS output sockets.
- The UPS can be operated by any individuals with no previous experience.
- Connect the UPS system only to an earthed shockproof outlet which must be easily accessible and close to the UPS system.
- Please use only VDE-tested, CE-marked mains cable (e.g. the mains cable of your computer) to connect the UPS system to the building wiring outlet (shockproof outlet).
- Please use only VDE-tested, CE-marked power cables to connect the loads to the UPS system.
- When installing the equipment, it should ensure that the sum of the leakage current of the UPS and the connected devices does not exceed 3.5mA.

1-4. Operation

- Do not disconnect the mains cable on the UPS system or the building wiring outlet (shockproof socket outlet) during operations since this would cancel the protective earthing of the UPS system and of all connected loads.
- The UPS system features its own, internal current source (batteries). The UPS output sockets or output terminals block may be electrically live even if the UPS system is not connected to the building wiring outlet.
- In order to fully disconnect the UPS system, first press the OFF/Enter button to disconnect the mains.
- Prevent no fluids or other foreign objects from inside of the UPS system.

1-5. Maintenance, service and faults

- The UPS system operates with hazardous voltages. Repairs may be carried out only by qualified maintenance personnel.
- **Caution** - risk of electric shock. Even after the unit is disconnected from the mains (building wiring outlet), components inside the UPS system are still connected to the battery and electrically live and dangerous.
- Before carrying out any kind of service and/or maintenance, disconnect the batteries and verify that no current is present and no hazardous voltage exists in the terminals of high capability capacitor such as BUS-capacitors.
- Only persons are adequately familiar with batteries and with the required precautionary measures may replace batteries and supervise operations. Unauthorized persons must be kept well away from the batteries.
- **Caution** - risk of electric shock. The battery circuit is not isolated from the input voltage. Hazardous voltages may occur between the battery terminals and the ground. Before touching, please verify that no voltage is present!
- Batteries may cause electric shock and have a high short-circuit current. Please take the precautionary measures specified below and any other measures necessary when working with batteries:
 - remove wristwatches, rings and other metal objects
 - use only tools with insulated grips and handles.
- When changing batteries, install the same number and same type of batteries.
- Do not attempt to dispose of batteries by burning them. This could cause battery explosion.
- Do not open or destroy batteries. Escaping electrolyte can cause injury to the skin and eyes. It may be toxic.
- Please replace the fuse only with the same type and amperage in order to avoid fire hazards.
- Do not dismantle the UPS system.

2. Installation and setup

NOTE: Before installation, please inspect the unit. Be sure that nothing inside the package is damaged. Please keep the original package in a safe place for future use.

NOTE: There are two different types of online UPS: standard and long-run models. Please refer to the following model table.

Model	Type	Model	Type
1K	Standard	1KL	Long-run
2K		2KL	
3K		3KL	

2-1. Rear panel view

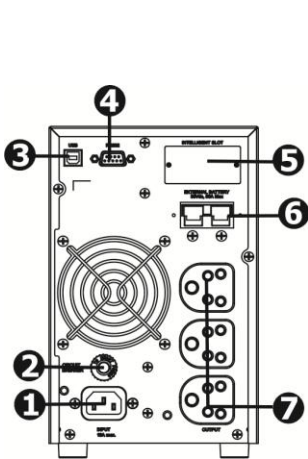

1K (L) India

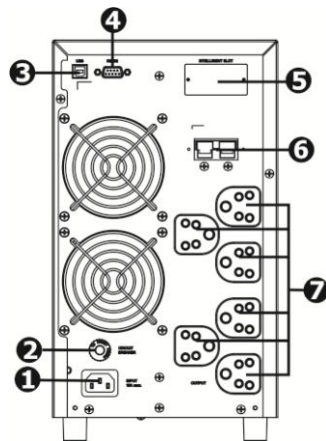

2K (L) India

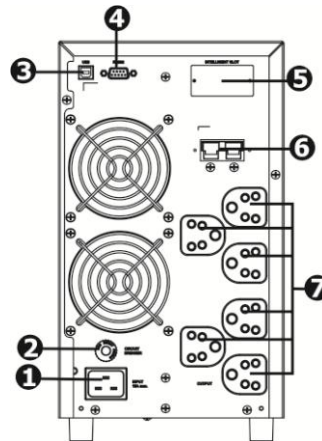

3K(L) India

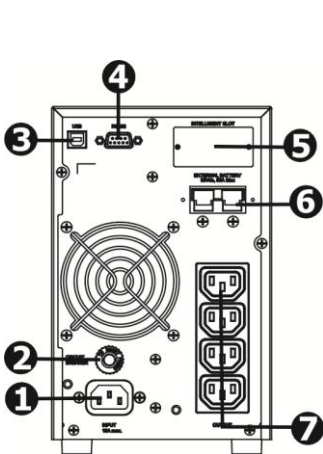

1K (L) IEC

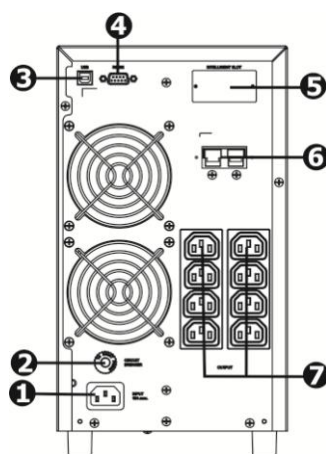

2K (L) IEC

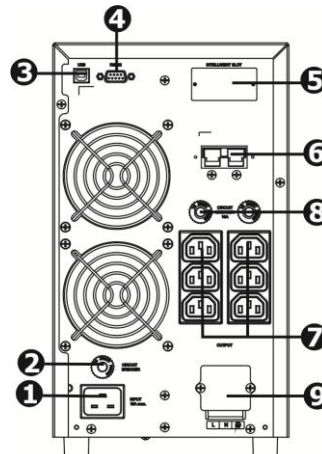

3K(L) IEC

1. AC input
2. Input circuit breaker
3. USB communication port
4. RS-232 communication port
5. SNMP intelligent slot
6. External battery connection (only available for L model)
7. Output receptacles

8. Output circuit breaker
9. Output terminal

2-2. Setup the UPS

Step 1: UPS input connection

Plug the UPS into a two-pole, three-wire, grounded receptacle only. Avoid using extension cords. The power cord is supplied in the UPS package.

Step 2: UPS output connection

- For socket-type outputs, simply connect devices to the outlets.
- For terminal-type input or outputs, please follow below steps for the wiring configuration:
 - a) Remove the small cover of the terminal block
 - b) Suggest using AWG14 or 2.1mm² power cords.
 - c) Upon completion of the wiring configuration, please check whether the wires are securely affixed.
 - d) Put the small cover back to the rear panel.

Step 3: Communication connection

Communication port:

USB port



RS-232 port

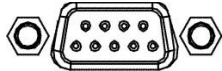

Intelligent slot



To allow for unattended UPS shutdown/start-up and status monitoring, connect the communication cable one end to the USB/RS-232 port and the other to the communication port of your PC. With the monitoring software installed, you can schedule UPS shutdown/start-up and monitor UPS status through PC.

The UPS is equipped with intelligent slot perfect for either SNMP or AS400 card. When installing either SNMP or AS400 card in the UPS, it will provide advanced communication and monitoring options.

PS. USB port and RS-232 port can't work at the same time.

Step 4: Turn on the UPS

Press the ON/Mute button on the front panel for two seconds to power on the UPS.

Note: The battery charges fully during the first five hours of normal operation. Do not expect full battery run capability during this initial charge period.

Step 5: Install software

For optimal computer system protection, install UPS monitoring software to fully configure UPS shutdown. You may insert provided CD into CD-ROM to install the monitoring software. If not, please follow steps below to download and install monitoring software from the internet:

1. Go to the website <http://www.power-software-download.com>
2. Click ViewPower software icon and then choose your required OS to download the software.
3. Follow the on-screen instructions to install the software.
4. When your computer restarts, the monitoring software will appear as an orange plug icon located in the system tray, near the clock.

Step 6: External battery connection (for long-run models only)

Follow the right chart to make external battery connection.

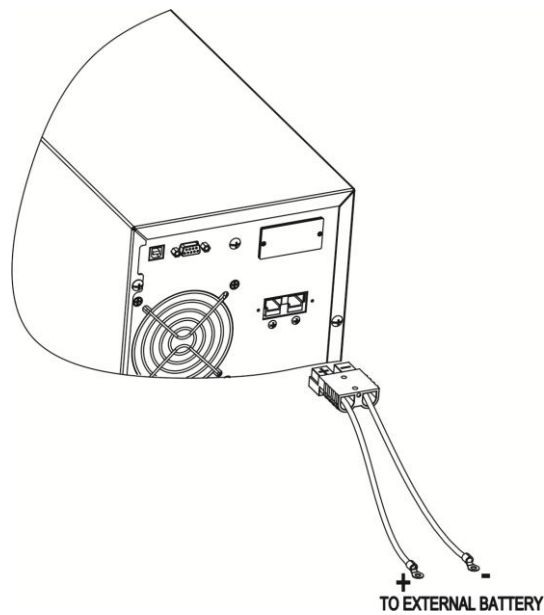









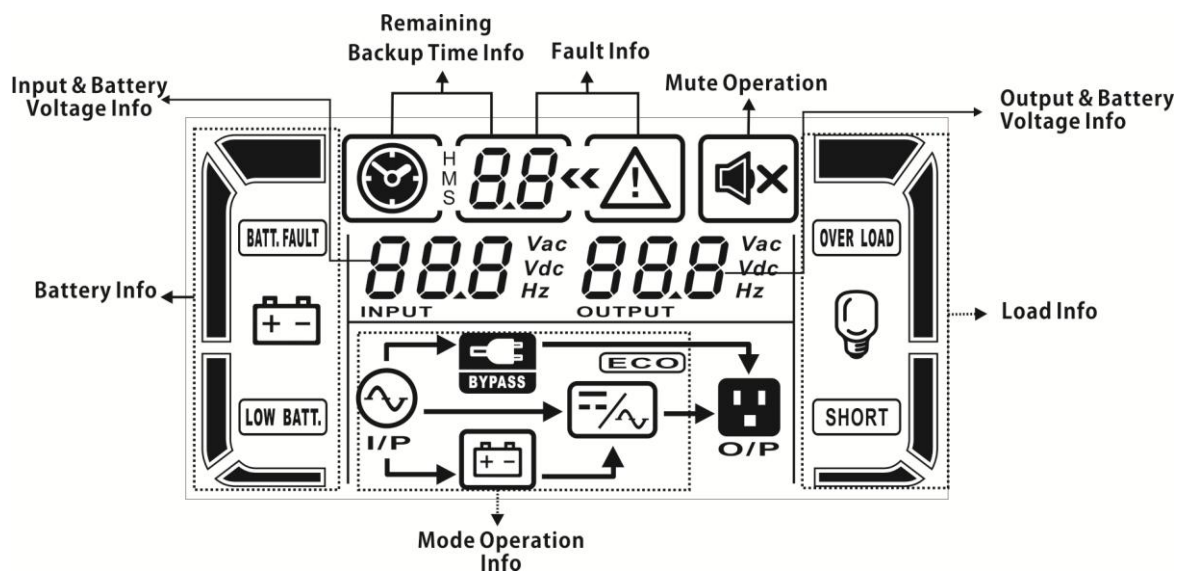











3. Operations

3-1. Button operation

Button	Function
ON/Mute Button	<ul style="list-style-type: none"> ➤ Turn on the UPS: Press and hold ON/Mute button for at least 2 seconds to turn on the UPS. ➤ Mute the alarm: When the UPS is on battery mode, press and hold this button for at least 5 seconds to disable or enable the alarm system. But it's not applied to the situations when warnings or errors occur. ➤ Up key: Press this button to display previous selection in UPS setting mode. ➤ Switch to UPS self-test mode: Press and hold ON/Mute button for 5 seconds to enter UPS self-testing while in AC mode, ECO mode, or converter mode.
OFF/Enter Button	<ul style="list-style-type: none"> ➤ Turn off the UPS: Press and hold this button at least 2 seconds to turn off the UPS in battery mode. UPS will be in standby mode under power normal or transfer to Bypass mode if the Bypass enable setting by pressing this button. ➤ Confirm selection key: Press this button to confirm selection in UPS setting mode.
Select Button	<ul style="list-style-type: none"> ➤ Switch LCD message: Press this button to change the LCD message for input voltage, input frequency, battery voltage, output voltage and output frequency. It will return back to default display when pausing for 10 seconds. ➤ Setting mode: Press and hold this button for 5 seconds to enter UPS setting mode when UPS is in standby mode or bypass mode. ➤ Down key: Press this button to display next selection in UPS setting mode.
ON/Mute + Select Button	<ul style="list-style-type: none"> ➤ Switch to bypass mode: When the main power is normal, press ON/Mute and Select buttons simultaneously for 5 seconds. Then UPS will enter to bypass mode. This action will be ineffective when the input voltage is out of acceptable range.

3-2. LCD Panel



Display	Function
Remaining backup time information	
	Indicates the remaining backup time in pie chart.
H M S 	Indicates the remaining backup time in numbers. H: hours, M: minute, S: second
Fault information	
	Indicates that the warning and fault occurs.
	Indicates the warning and fault codes, and the codes are listed in details in 3-5 section.
Mute operation	
	Indicates that the UPS alarm is disabled.
Output & Battery voltage information	
 OUTPUT	Indicates the output voltage, frequency or battery voltage. Vac: output voltage, Vdc: battery voltage, Hz: frequency
Load information	
	Indicates the load level by 0-25%, 26-50%, 51-75%, and 76-100%.
	Indicates overload.
	Indicates the load or the UPS output is short circuit.
Mode operation information	
	Indicates the UPS connects to the mains.
	Indicates the battery is working.
	Indicates the bypass circuit is working.
	Indicates the ECO mode is enabled.
	Indicates the Inverter circuit is working.
	Indicates the output is working.
Battery information	
	Indicates the Battery level by 0-25%, 26-50%, 51-75%, and 76-100%.
	Indicates the battery is fault.
	Indicates low battery level and low battery voltage.
Input & Battery voltage information	
 INPUT 12	Indicates the input voltage or frequency or battery voltage. Vac: Input voltage, Vdc: battery voltage, Hz: input frequency

3-3. Audible Alarm

Battery Mode	Sounding every 4 seconds
Low Battery	Sounding every second
Overload	Sounding twice every second
Fault	Continuously sounding
Bypass Mode	Sounding every 10 seconds

3-4. LCD display wordings index

Abbreviation	Display content	Meaning
ENA	<i>ENA</i>	Enable
DIS	<i>DIS</i>	Disable
ESC	<i>ESC</i>	Escape
HLS	<i>HLS</i>	High loss
LLS	<i>LLS</i>	Low loss
BAT	<i>BAT</i>	Battery
CF	<i>CF</i>	Converter
TP	<i>TP</i>	Temperature
CH	<i>CH</i>	Charger

3-5. UPS Setting

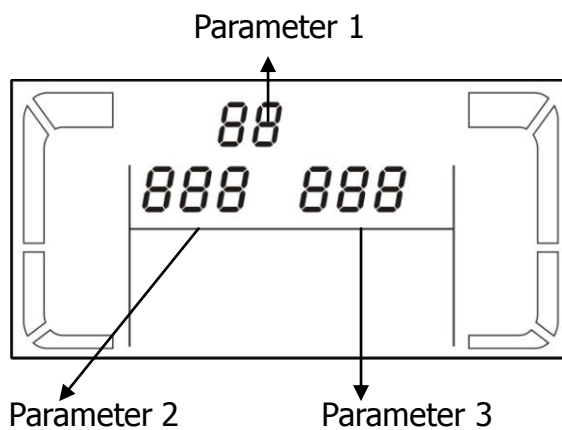

There are three parameters to set up the UPS.

Parameter 1: It's for program alternatives. There are 8 programs to set up. Refer to below table. Parameter 2 and parameter 3 are the setting options or values for each program.

● 01: Output voltage setting

Interface	Setting
<p>The diagram shows the LCD display with '01<<' in the top left and '230 Vac' in the center, with 'OUTPUT' written below it.</p>	<p>Parameter 3: Output voltage For 200/208/220/230/240 VAC models, you may choose the following output voltage: 200: presents output voltage is 200Vac 208: presents output voltage is 208Vac 220: presents output voltage is 220Vac 230: presents output voltage is 230Vac 240: presents output voltage is 240Vac For 100/110/115/120/127 VAC models, you may choose</p>

	<p>the following output voltage:</p> <p>100: presents output voltage is 100Vac 110: presents output voltage is 110Vac 115: presents output voltage is 115Vac 120: presents output voltage is 120Vac 127: presents output voltage is 127Vac</p>
--	---

● **02: Frequency Converter enable/disable**

Interface	Setting
	<p>Parameter 2 & 3: Enable or disable converter mode. You may choose the following two options:</p> <p>CF ENA: converter mode enable CF DIS: converter mode disable</p>

● **03: Output frequency setting**

Interface	Setting
	<p>Parameter 2 & 3: Output frequency setting. You may set the initial frequency on battery mode: BAT 50: presents output frequency is 50Hz BAT 60: presents output frequency is 60Hz If converter mode is enabled, you may choose the following output frequency: CF 50: presents output frequency is 50Hz CF 60: presents output frequency is 60Hz</p>

● **04: ECO enable/disable**

Interface	Setting
	<p>Parameter 3: Enable or disable ECO function. You may choose the following two options:</p> <p>ENA: ECO mode enable DIS: ECO mode disable</p>

● **05: ECO voltage range setting**

Interface	Setting
	<p>Parameter 2 & 3: Set the acceptable high voltage point and low voltage point for ECO mode by pressing Down key or Up key.</p> <p>HLS: High loss voltage in ECO mode in parameter 2. For 200/208/220/230/240 VAC models, the setting range in parameter 3 is from +7V to +24V of the nominal voltage. For 100/110/115/120/127 VAC models, the setting range in parameter 3 is from +3V to +12V of the nominal voltage.</p> <p>LLS: Low loss voltage in ECO mode in parameter 2. For 200/208/220/230/240 VAC models, the setting range in parameter 3 is from -7V to -24V of the nominal voltage. For 100/110/115/120/127 VAC models, the setting voltage in parameter 3 is from -3V to -12V of the nominal voltage.</p>

● **06: Bypass enable/disable when UPS is off**

Interface	Setting
	<p>Parameter 3: Enable or disable Bypass function. You may choose the following two options: ENA: Bypass enable DIS: Bypass disable</p>

● **07: Bypass voltage range setting**

Interface	Setting
	<p>Parameter 2 & 3: Set the acceptable high voltage point and acceptable low voltage point for Bypass mode by pressing the Down key or Up key. HLS: Bypass high voltage point For 200/208/220/230/240 VAC models: 230-264: setting the high voltage point in parameter 3 from 230Vac to 264Vac. For 100/110/115/120/127 VAC models: 120-132: setting the high voltage point in parameter 3 from 120Vac to 132Vac LLS: Bypass low voltage point For 200/208/220/230/240 VAC models: 170-220: setting the low voltage point in parameter 3 from 170Vac to 220Vac For 100/110/115/120/127 VAC models: 85-115: setting the low voltage point in parameter 3 from 85Vac to 115Vac.</p>

● **8: Backup time setting for outlets**

Interface	Setting
	<p>Parameter 3: Set up backup time on battery mode for general outlets. 0-999: setting the backup time in minutes from 0-999 for general outlets on battery mode. 0: When setting as "0", the backup time will be only 10 seconds. 999: When setting as "999", the backup time setting will be disabled.</p>

● **00: Exit setting**



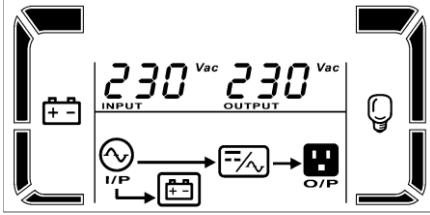
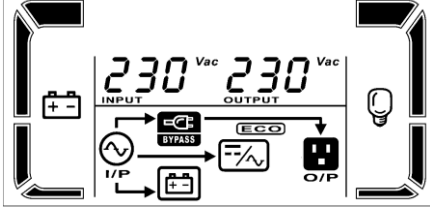
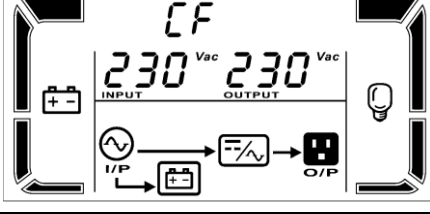
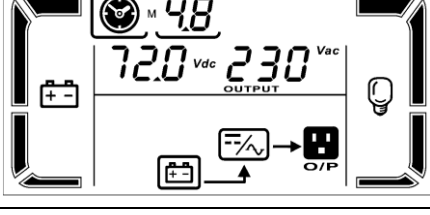
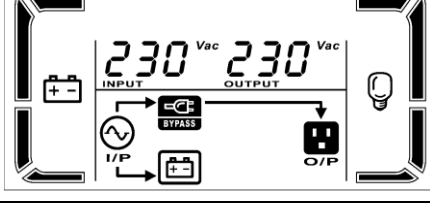
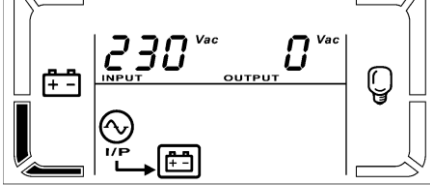











3-6. Operating Mode Description

Operating mode	Description	LCD display
Online mode	When the input voltage is within acceptable range, UPS will provide pure and stable AC power to output. The UPS will also charge the battery at online mode.	
ECO mode	Energy saving mode: When the input voltage is within voltage regulation range, UPS will bypass voltage to output for energy saving.	
Frequency Converter mode	When input frequency is within 40 Hz to 70 Hz, the UPS can be set at a constant output frequency, 50 Hz or 60 Hz. The UPS will still charge battery under this mode.	
Battery mode	When the input voltage is beyond the acceptable range or power failure and alarm is sounding every 4 second, UPS will backup power from battery.	
Bypass mode	When input voltage is within acceptable range but UPS is overload, UPS will enter bypass mode or bypass mode can be set by front panel. Alarm is sounding every 10 second.	
Standby mode	UPS is powered off and no output supply power, but still can charge batteries.	

3-7. Faults Reference Code









Fault event	Fault code	Icon	Fault event	Fault code	Icon
Bus start fail	01	x	Inverter voltage Low	13	X
Bus over	02	x	Inverter output short	14	SHORT
Bus under	03	x	Battery voltage too high	27	BATT.FAULT
Bus unbalance	04	x	Battery voltage too low	28	BATT.FAULT
Bus short	05	x	Over temperature	41	X
Inverter soft start fail	11	x	Over load	43	OVER LOAD
Inverter voltage high	12	x			

3-8. Warning indicator

Warning	Icon (flashing)	Alarm
Low Battery	 	Sounding every second
Overload	 	Sounding twice every second
Battery is not connected	 	Sounding every second
Over Charge	 	Sounding every second
Over temperature	 	Sounding every second
Charger failure	 	Sounding every second
Out of bypass voltage range	 	Sounding every second

4. Troubleshooting

If the UPS system does not operate correctly, please solve the problem by using the table below.

Symptom	Possible cause	Remedy
No indication and alarm even though the mains is normal.	The AC input power is not connected well.	Check if input power cord firmly connected to the mains.
	The AC input is connected to the UPS output.	Plug AC input power cord to AC input correctly.
The icon  and  flashing on LCD display and alarm is sounding every second.	The external or internal battery is incorrectly connected.	Check if all batteries are connected well.
Fault code is shown as 27 and the icon  is lighting on LCD display and alarm is continuously sounding.	Battery voltage is too high or the charger is fault.	Contact your dealer.
Fault code is shown as 28 and the icon  is lighting on LCD display and alarm is continuously sounding.	Battery voltage is too low or the charger is fault.	Contact your dealer.
The icon  and  is flashing on LCD display and alarm is sounding twice every second.	UPS is overload	Remove excess loads from UPS output.
	UPS is overloaded. Devices connected to the UPS are fed directly by the electrical network via the Bypass.	Remove excess loads from UPS output.
	After repetitive overloads, the UPS is locked in the Bypass mode. Connected devices are fed directly by the mains.	Remove excess loads from UPS output first. Then shut down the UPS and restart it.
Fault code is shown as 43 and The icon  is lighting on LCD display and alarm is continuously sounding.	The UPS shut down automatically because of overload at the UPS output.	Remove excess loads from UPS output and restart it.
Fault code is shown as 14 and the icon  is lighting on LCD display and alarm is continuously sounding.	The UPS shut down automatically because short circuit occurs on the UPS output.	Check output wiring and if connected devices are in short circuit status.
Fault code is shown as 01, 02, 03, 04, 11, 12, 13 and 41 on LCD display and alarm is continuously sounding.	A UPS internal fault has occurred. There are two possible results: 1. The load is still supplied, but directly from AC power via bypass. 2. The load is no longer supplied by power.	Contact your dealer

Symptom	Possible cause	Remedy
Battery backup time is shorter than nominal value	Batteries are not fully charged	Charge the batteries for at least 5 hours and then check capacity. If the problem still persists, consult your dealer.
	Batteries defect	Contact your dealer to replace the battery.
Fault code is shown as 05 on LCD display. At the same time, alarm is continuously sounding and output is cut off	A UPS internal fault has occurred and BUS is short circuit	Consult your dealer. If the UPS power is on again before repair, the DC/DC mosfet will damage.

5. Storage and Maintenance

Operation

The UPS system contains no user-serviceable parts. If the battery service life (3~5 years at 25°C ambient temperature) has been exceeded, the batteries must be replaced. In this case, please contact your dealer.



Be sure to deliver the spent battery to a recycling facility or ship it to your dealer in the replacement battery packing material.

Storage

Before storing, charge the UPS 5 hours. Store the UPS covered and upright in a cool, dry location. During storage, recharge the battery in accordance with the following table:

Storage Temperature	Recharge Frequency	Charging Duration
-25°C - 40°C	Every 3 months	1-2 hours
40°C - 45°C	Every 2 months	1-2 hours

6. Specifications

CAPACITY*		1000 VA / 800 W	2000 VA / 1600 W	3000 VA / 2400 W		
INPUT						
Voltage Range	Low Line Transfer	160VAC/140VAC/120VAC/110VAC±5% (based on load percentage 100% - 80 % / 80 % - 70 % / 70 - 60 % / 60 % - 0)				
	Low Line Comeback	168VAC/148VAC/128VAC/118VAC ± 5 % (based on load percentage 100% - 80 % / 80 % - 70 % / 70 - 60 % / 60 % - 0)				
	High Line Transfer	300 VAC ± 5 %				
	High Line Comeback	290 VAC ± 5 %				
Frequency Range		40Hz ~ 70 Hz				
Phase		Single phase with ground				
Power Factor		≥ 0.99 @ nominal voltage (input voltage)				
OUTPUT						
Output voltage		200/208/220/230/240VAC				
AC Voltage Regulation		± 1% (Batt. Mode)				
Frequency Range (Synchronized Range)		47 ~ 53 Hz or 57 ~ 63 Hz				
Frequency Range (Batt. Mode)		50 Hz ± 0.25 Hz or 60Hz ± 0.3 Hz				
Current Crest Ratio		3:1				
Harmonic Distortion		≤ 2 % THD (Linear Load) ≤ 4 % THD (Non-linear Load)				
Transfer Time	AC Mode to Batt. Mode	Zero				
	Inverter to Bypass	4 ms (Typical)				
Waveform (Batt. Mode)		Pure Sinewave				
EFFICIENCY						
AC Mode		87%	90%			
Battery Mode		83%	87%	89%		
BATTERY						
Standard Model	Battery Type	12 V / 7 AH	12 V / 7 AH		12 V / 9 AH	
	Numbers	3	6	8	6	8
	Recharge Time	4 hours recover to 90% capacity (Typical)				
	Charging Current	1.0 A (max.)				
Long-run Model	Charging Voltage	41.0VDC ± 1%	82.1 VDC ±1%	109.4VDC ±1%	82.1 VDC ±1%	109.4VDC ±1%
	Battery Type & Numbers	Depending on the capacity of external batteries				
	Charging Current	1.0A/2.0A/4.0A/6.0 A				
Standard Model	Charging Voltage	41.0VDC ± 1%	82.1 VDC ±1%	109.4VDC ±1%	82.1 VDC ±1%	109.4VDC ±1%
	Dimension, D X W X H	397 X 145 X 220 (mm)	419 X 190 X 318 (mm)			
Long-run Model	Net Weight (kgs)	13	26	30.5	28	33
	Dimension, D X W X H	397 X 145 X 220 (mm)	419 X 190 X 318 (mm)			
Long-run Model	Net Weight (kgs)	7	13		13	
	ENVIRONMENT					
Operation Humidity		20-90 % RH @ 0- 40°C (non-condensing)				
Noise Level		Less than 45dBA @ 1 Meter				
MANAGEMENT						
Smart RS-232 or USB		Supports Windows® 2000/2003/XP/Vista/2008/7, Linux, Unix and MAC				
Optional SNMP		Power management from SNMP manager and web browser				

* Derate capacity to 80% of capacity in Frequency converter mode or when the output voltage is adjusted to 208VAC/200VAC.

** Product specifications are subject to change without further notice.